

Anschlussmaß innen  
min.  $\varnothing 270$   
Connection size inside  
min.  $\varnothing 270$

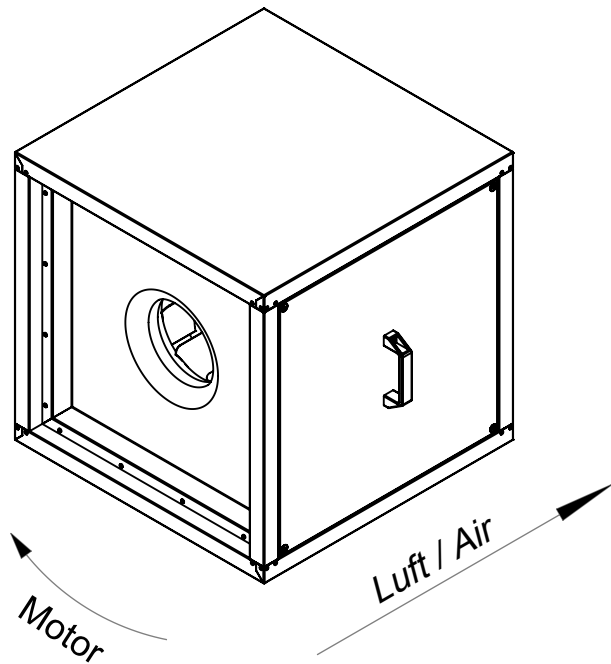
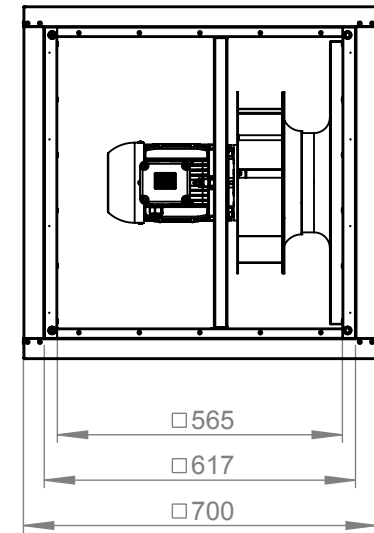

1:20 A4 mm

**ruck**<sup>EU</sup>  
VENTILATOREN

Protection Mark  
according to ISO16016

General tolerances  
DIN ISO 2768-c

**MPC315D430**

ruck Ventilatoren  
Max-Planck-Str. 5  
D-97944 Boxberg

Drawn: d.hancu  
Created: d.hancu  
Changed:

18.08.17  
18.08.17

**141081 00**